

AL-PRODUCTEN

Inhoudsopgave

Alround kabelladders

Pagina 4

Kabelladder met gesloten boomprofiel
Zware industriële kabelladder

Alround
kabelladders

Altube kabelbuizen

Pagina 26

Kabelbuizen

Altube
kabelbuizen

Alstrut montagesystemen

Pagina 38

Montagesystemen
Ondersteuningssystemen
Bevestigingsmateriaal

Alstrut
montage-
systemen



KABELDRAAGSYSTEMEN VOOR INDUSTRIE EN INFRA

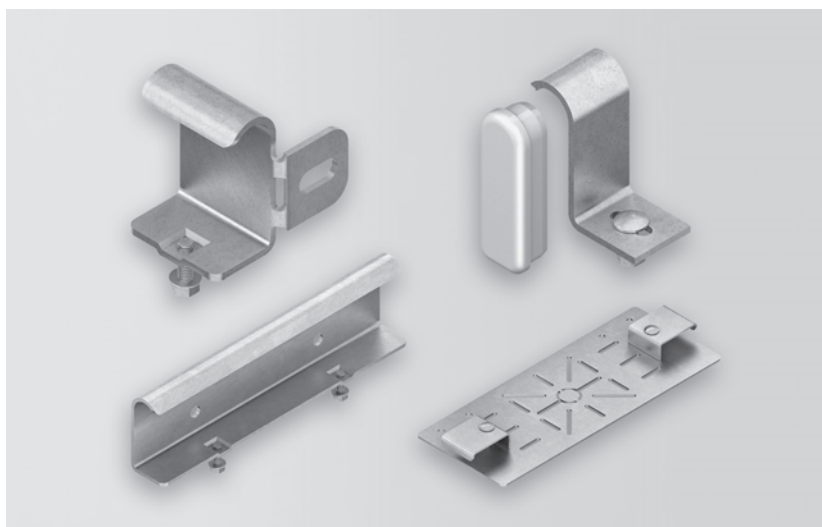
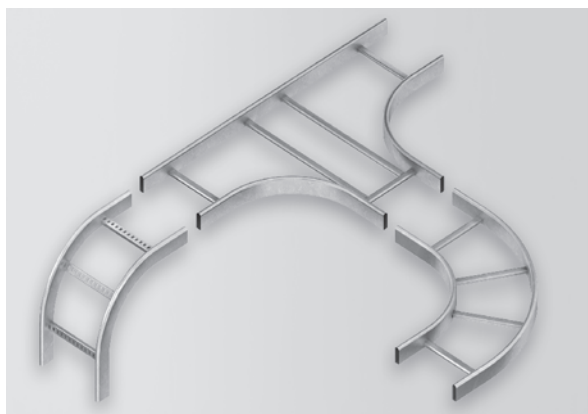
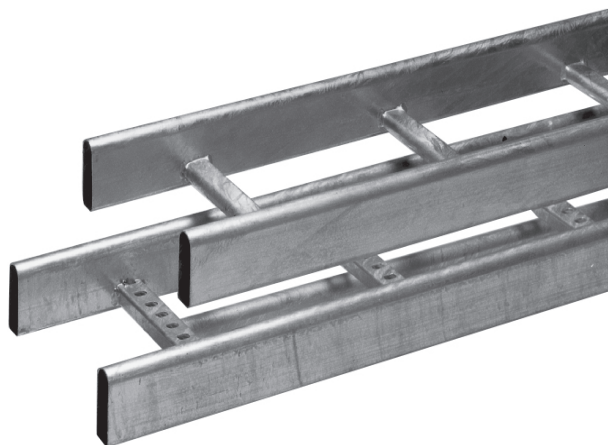



ALROUND KABELLADDER MET GESLOTEN BOOMPROFIEL

Alround kabladder

de gesloten boomprofielen maken het verschil
onder de standaard ladders

Hoge mechanische stevigheid

door optimale materiaalvorm en gelaste sporten

Hoge belasting

bij grote ondersteuningsafstand

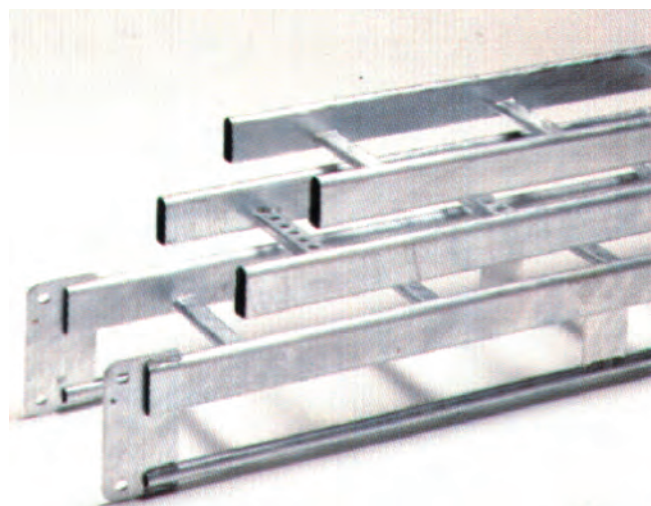

Breed inzetbaar

in industrie en utiliteit voor zowel binnen- als buitengebruik

Compleet systeem

met hulpstukken en toebehoren voor elke situatie

ALROUND KABELLADDER

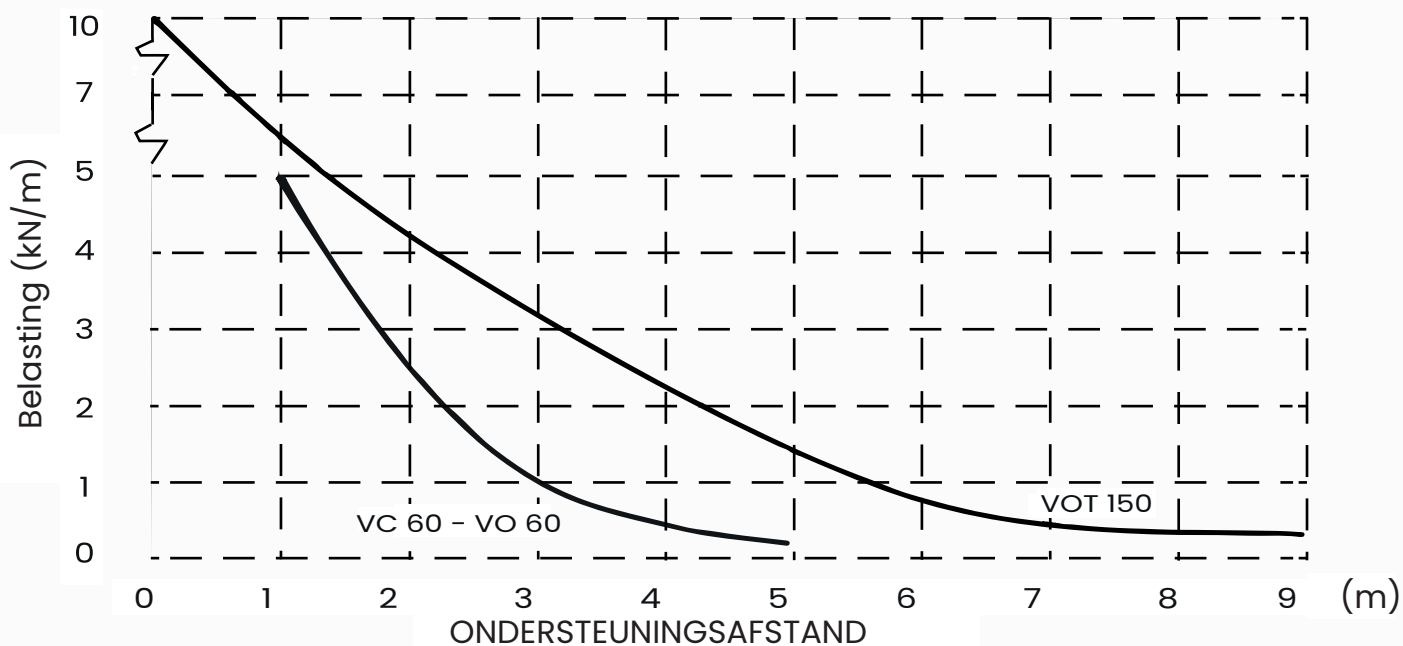

- 1 kabelladder VC60
- 2 kabelladder VO60
- 3 kabelladder VOT150
- 4 stijgstuk 90° VO60/ VOC60
- 5 vervalstuk 90° VO60/VOC60
- 6 vervalstuk 90° VOT150
- 7 binnenbocht 90° VO60/VOC60
- 8 buitenbocht 90° VO60/VOC60
- 9 T-stuk VO60/VOC60
- 10 X-stuk VO60/VOC60
- 11 hoekplaat VO60/VOT150
- 12 koppeling recht VOC60
- 13 koppeling universeel instelbaar VOC60
- 14 koppeling recht VOT150
- 15 koppeling horizontaal instelbaar VOT150
- 16 koppeling verticaal instelbaar VOT150
- 17 koppeling inzetplaat VOT150
- 18 pendelhaak VOC60
- 19 aftakhaak VOC60
- 20 eindbevestiging links VOC60
- 21 eindbevestiging rechts VOC60
- 22 wandbevestiging VOC60
- 23 profielklem VOC60
- 24 profielklem VOT150
- 25 profielsteun VOT150
- 26 eindkap VOC60 (boomprofiel)
- 27 eindkap VOT150 (trekstang)
- 28 scheidingschot
- 29 horizontale montageplaat
- 30 verticale montageplaat
- 31 dekselondersteuning
- 32 deksel kabelladder
- 33 aftakhaak VOT

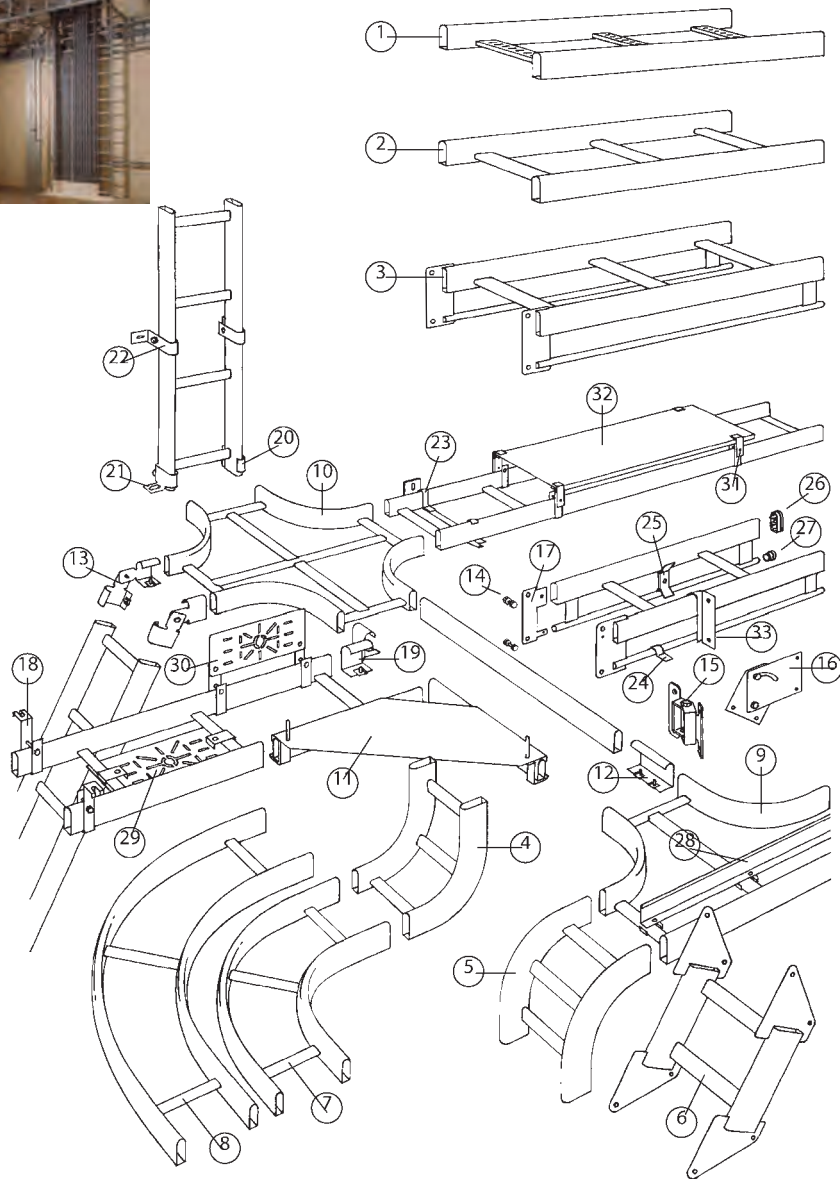

Uitvoering

- VC60: volbad thermisch verzinkt volgens EN ISO 1461, C-vormige geperforeerde sporten. Sportafstand is 250 mm.
- VO60: volbad thermisch verzinkt volgens EN ISO 1461, plat-ovale gesloten sporten. Sportafstand is 250 mm.
- VOT150: volbad thermisch verzinkt volgens EN ISO 1461, plat-ovale gesloten sporten, sportafstand is 250 mm. Voorzien van trekstang Ø 19 mm voor extra sterkte.

Op aanvraag leverbaar

Verzinkte poedergecoate uitvoering.
Afwijkende breedten.
Afwijkende sportafstanden.

AL-PRODUCTEN

Boomdoorsnede

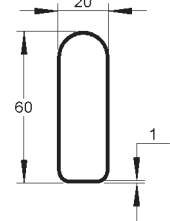

Sportdoorsnede

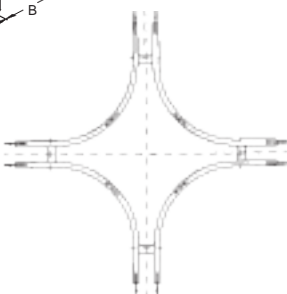
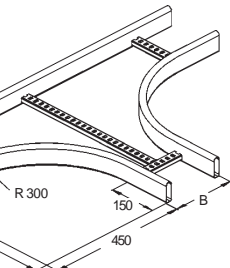
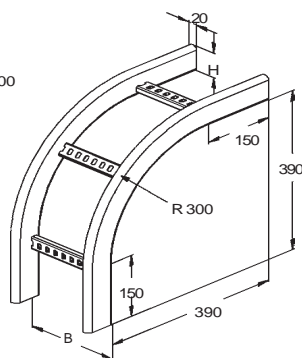
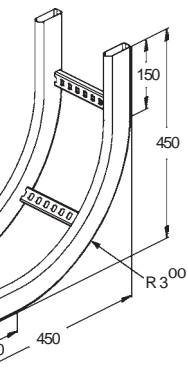
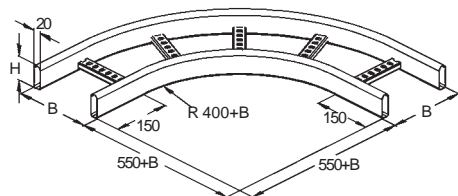
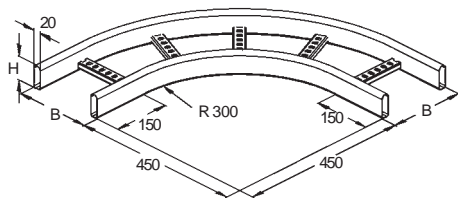
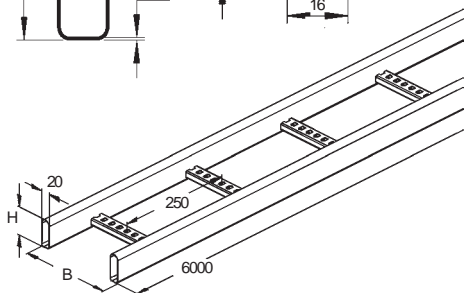
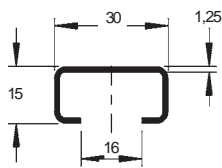

NIEDAX Typenummer	Afmetingen mm H x B	Artikel Nummer	kg Stuk/m	VPE	Korting groep
----------------------	---------------------------	-------------------	--------------	-----	------------------

V Kabelladder VC60 lengte 6 meter
geperforeerde C - sport (vulhoogte 40 mm)

Kabelladder 100	60 x 100	40011	2,67	6 m	HA
Kabelladder 200	60 x 200	40012	2,94	6 m	HA
Kabelladder 300	60 x 300	40013	3,21	6 m	HA
Kabelladder 400	60 x 400	40014	3,48	6 m	HA
Kabelladder 500	60 x 500	40015	3,74	6 m	HA
Kabelladder 600	60 x 600	40016	4,01	6 m	HA

V Binnenbocht 90° VC60
geperforeerde C - sport

Binnenbocht 100	60 x 100	41021	2,30	p/stuk	HA
Binnenbocht 200	60 x 200	41022	2,80	p/stuk	HA
Binnenbocht 300	60 x 300	41023	3,20	p/stuk	HA
Binnenbocht 400	60 x 400	41024	4,00	p/stuk	HA
Binnenbocht 500	60 x 500	41025	4,50	p/stuk	HA
Binnenbocht 600	60 x 600	41026	5,60	p/stuk	HA

V Buitenbocht 90° VC60
geperforeerde C - sport

Buitenbocht 100	60 x 100	41031	3,10	p/stuk	HA
Buitenbocht 200	60 x 200	41032	4,20	p/stuk	HA
Buitenbocht 300	60 x 300	41033	5,20	p/stuk	HA
Buitenbocht 400	60 x 400	41034	6,50	p/stuk	HA
Buitenbocht 500	60 x 500	41035	8,50	p/stuk	HA
Buitenbocht 600	60 x 600	41036	9,60	p/stuk	HA

V Stijgstuk 90° VC60
geperforeerde C - sport

Stijgstuk 100	60 x 100	41001	1,90	p/stuk	HA
Stijgstuk 200	60 x 200	41002	2,10	p/stuk	HA
Stijgstuk 300	60 x 300	41003	2,30	p/stuk	HA
Stijgstuk 400	60 x 400	41004	2,50	p/stuk	HA
Stijgstuk 500	60 x 500	41005	2,80	p/stuk	HA
Stijgstuk 600	60 x 600	41006	3,00	p/stuk	HA

V Vervalstuk 90° VC60
geperforeerde C - sport

Vervalstuk 100	60 x 100	41011	1,90	p/stuk	HA
Vervalstuk 200	60 x 200	41012	2,10	p/stuk	HA
Vervalstuk 300	60 x 300	41013	2,30	p/stuk	HA
Vervalstuk 400	60 x 400	41014	2,50	p/stuk	HA
Vervalstuk 500	60 x 500	41015	2,80	p/stuk	HA
Vervalstuk 600	60 x 600	41016	3,00	p/stuk	HA

V T - Stuk VC60
geperforeerde C - sport

T-Stuk 100	60 x 100	41041	3,40	p/stuk	HA
T-Stuk 200	60 x 200	41042	4,10	p/stuk	HA
T-Stuk 300	60 x 300	41043	4,80	p/stuk	HA
T-Stuk 400	60 x 400	41044	5,60	p/stuk	HA
T-Stuk 500	60 x 500	41045	6,30	p/stuk	HA
T-Stuk 600	60 x 600	41046	7,00	p/stuk	HA

V Kruisstuk VC60
geperforeerde C - sport

Kruisstuk 100	60 x 100	41051	4,10	p/stuk	HA
Kruisstuk 200	60 x 200	41052	5,10	p/stuk	HA
Kruisstuk 300	60 x 300	41053	6,00	p/stuk	HA
Kruisstuk 400	60 x 400	41054	7,00	p/stuk	HA
Kruisstuk 500	60 x 500	41055	7,80	p/stuk	HA
Kruisstuk 600	60 x 600	41056	8,60	p/stuk	HA

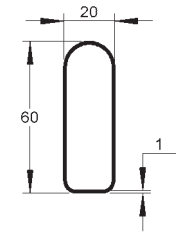
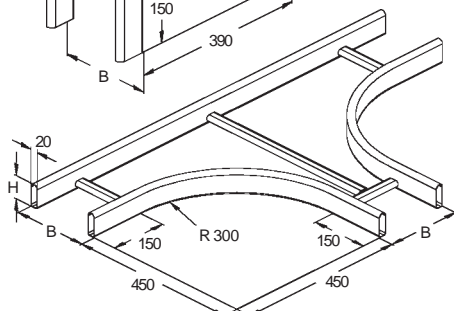
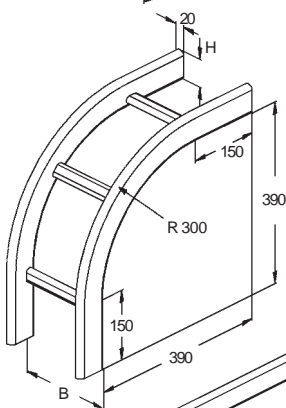
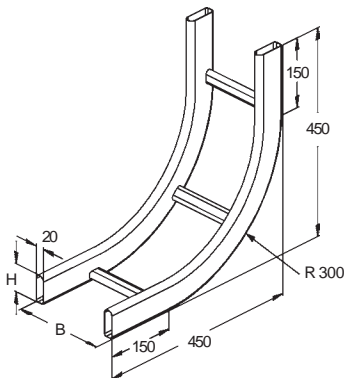
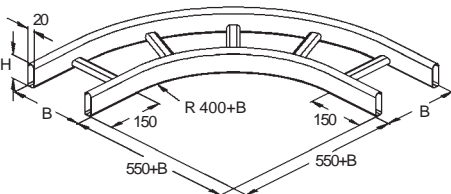
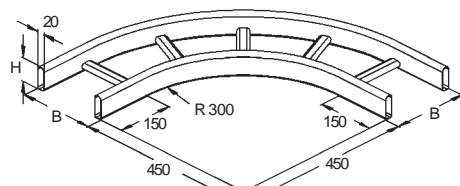
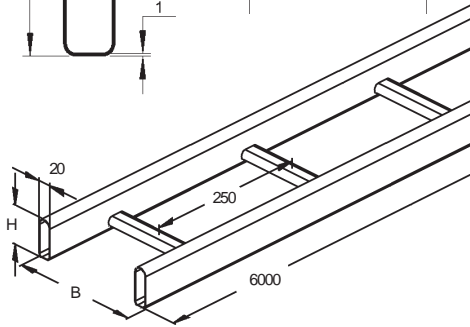
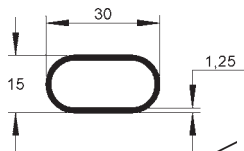

Boomdoorsnede

Sportdoorsnede

* KRUISSTUKKEN leverbaar

NIEDAX Typenummer	Afmetingen mm H x B	Artikel Nummer	kg stuk/m	VPE	Korting groep
----------------------	---------------------------	-------------------	--------------	-----	------------------

V Kabelladder VO60 lengte 6 meter
plat-ovaal, gesloten sport (vulhoogte 40 mm)

Kabelladder 100	60 x 100	40001	2,70	6 m	HA
Kabelladder 200	60 x 200	40002	3,03	6 m	HA
Kabelladder 300	60 x 300	40003	3,36	6 m	HA
Kabelladder 400	60 x 400	40004	3,69	6 m	HA
Kabelladder 500	60 x 500	40005	4,02	6 m	HA
Kabelladder 600	60 x 600	40006	4,35	6 m	HA
Kabelladder 800	60 x 800	40008	5,00	6 m	HA
Kabelladder 1000	60 x 1000	40010	5,66	6 m	HA

V Binnenbocht 90° VO60 - stofarm
plat-ovaal, gesloten sport

Binnenbocht 100	60 x 100	41831	2,30	p/stuk	HA
Binnenbocht 200	60 x 200	41832	2,80	p/stuk	HA
Binnenbocht 300	60 x 300	41833	3,20	p/stuk	HA
Binnenbocht 400	60 x 400	41834	4,00	p/stuk	HA
Binnenbocht 500	60 x 500	41835	4,50	p/stuk	HA
Binnenbocht 600	60 x 600	41836	5,60	p/stuk	HA
Binnenbocht 800	60 x 800	41838	7,20	p/stuk	HA
Binnenbocht 1000	60 x 1000	41840	9,40	p/stuk	HA

V Buitenbocht 90° VO60 - stofarm
plat-ovaal, gesloten sport

Buitenbocht 100	60 x 100	41841	3,10	p/stuk	HA
Buitenbocht 200	60 x 200	41842	4,20	p/stuk	HA
Buitenbocht 300	60 x 300	41843	5,20	p/stuk	HA
Buitenbocht 400	60 x 400	41844	6,50	p/stuk	HA
Buitenbocht 500	60 x 500	41845	8,50	p/stuk	HA
Buitenbocht 600	60 x 600	41846	9,60	p/stuk	HA
Buitenbocht 800	60 x 800	41848	13,30	p/stuk	HA
Buitenbocht 1000	60 x 1000	41850	17,30	p/stuk	HA

V Stijgstuk 90° VO60 - stofarm
plat-ovaal, gesloten sport

Stijgstuk 100	60 x 100	41811	1,90	p/stuk	HA
Stijgstuk 200	60 x 200	41812	2,10	p/stuk	HA
Stijgstuk 300	60 x 300	41813	2,30	p/stuk	HA
Stijgstuk 400	60 x 400	41814	2,50	p/stuk	HA
Stijgstuk 500	60 x 500	41815	2,80	p/stuk	HA
Stijgstuk 600	60 x 600	41816	3,00	p/stuk	HA
Stijgstuk 800	60 x 800	41818	3,40	p/stuk	HA
Stijgstuk 1000	60 x 1000	41820	3,70	p/stuk	HA

V Vervalstuk 90° VO60 - stofarm
plat-ovaal, gesloten sport

Vervalstuk 100	60 x 100	41821	1,90	p/stuk	HA
Vervalstuk 200	60 x 200	41822	2,10	p/stuk	HA
Vervalstuk 300	60 x 300	41823	2,30	p/stuk	HA
Vervalstuk 400	60 x 400	41824	2,50	p/stuk	HA
Vervalstuk 500	60 x 500	41825	2,80	p/stuk	HA
Vervalstuk 600	60 x 600	41826	3,00	p/stuk	HA
Vervalstuk 800	60 x 800	41828	3,40	p/stuk	HA
Vervalstuk 1000	60 x 1000	41830	3,70	p/stuk	HA

V T - Stuk VO60 - stofarm
plat-ovaal, gesloten sport

T-Stuk 100	60 x 100	41851	3,40	p/stuk	HA
T-Stuk 200	60 x 200	41852	4,10	p/stuk	HA
T-Stuk 300	60 x 300	41853	4,80	p/stuk	HA
T-Stuk 400	60 x 400	41854	5,60	p/stuk	HA
T-Stuk 500	60 x 500	41855	6,30	p/stuk	HA
T-Stuk 600	60 x 600	41856	7,00	p/stuk	HA
T-Stuk 800	60 x 800	41858	8,10	p/stuk	HA
T-Stuk 1000	60 x 1000	41860	9,90	p/stuk	HA

NIEDAX Typenummer	Afmetingen mm H x B	Artikel Nummer		kg stuk/m	VPE	Korting groep
----------------------	---------------------------	-------------------	--	--------------	-----	------------------

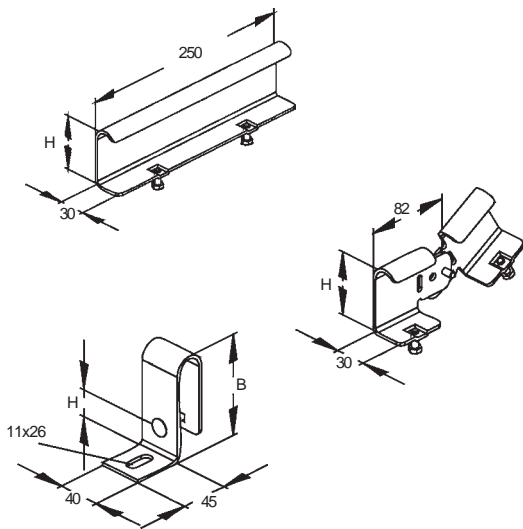

V Koppeling VOC60, recht

Koppeling	61	41203		0,69	10 St.	HA
-----------	----	--------------	--	------	--------	----

V Koppeling VOC60, universeel instelbaar horizontaal en verticaal

Koppeling	61	41204		0,34	10 St.	HA
-----------	----	--------------	--	------	--------	----

V Wandbevestiging VOC60

Wandbevestiging	25	94	41230	0,22	10 St.	HA
Wandbevestiging	75	144	41231	0,27	10 St.	HA

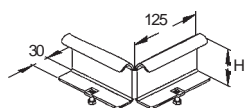

V Aftakhaak VOC60

Aftakhaak	61	41221		0,69	p/stuk	HA
-----------	----	--------------	--	------	--------	----

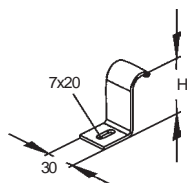

V Profielklem VOC60, inclusief bevestigingsmateriaal

Profielklem	57	41235		0,10	10 St.	HA
-------------	----	--------------	--	------	--------	----

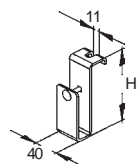

V Pendelhaak VOC60

Pendelhaak	114	41220		0,25	10 St.	HA
------------	-----	--------------	--	------	--------	----

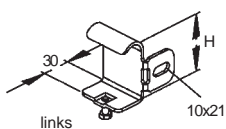

V Eindbevestiging VOC60

Eindbev. links	61	41225		0,18	10 St.	HA
Eindbev. rechts	61	41226		0,18	10 St.	HA

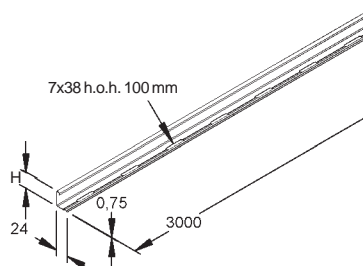
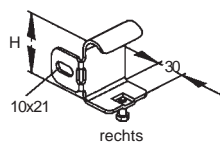

V Scheidingsschot VOC/ VOT

lengte 3 m

Inclusief 3 houders per lengte

Scheidingsschot	30 x 25	41500		0,54	3 m	HA
-----------------	---------	--------------	--	------	-----	----



NIEDAX Typenummer	Afmetingen mm H x B	Artikel Nummer		kg stuk	VPE	Korting groep
----------------------	---------------------------	-------------------	--	------------	-----	------------------



V Gootbevestigingsklem VOC/ VOT, inclusief bevestigingsmateriaal

Bev. klem		41252		0,03	10 St.	HA
-----------	--	-------	--	------	--------	----

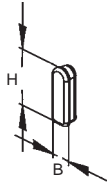

K Eindkap VOC/ VOT, voor boomprofiel.

Eindkap 60	60 x 20	41245		0,01	10/50 St.	HA
Eindkap 60 blauw	60 x 20	41247		0,01	10/50 St.	HA

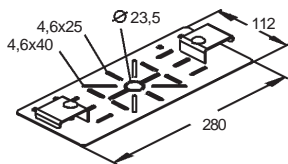

V Montageplaat VOC/ VOT, horizontaal

Montageplaat		41250		0,82	5 St.	HA
--------------	--	-------	--	------	-------	----

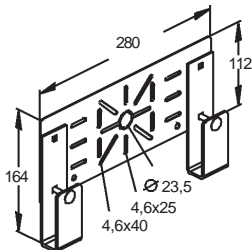

V Montageplaat VOC/ VOT, verticaal

Montageplaat		41251		0,82	5 St.	HA
--------------	--	-------	--	------	-------	----

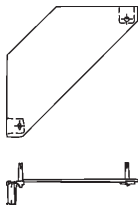

V Hoekplaat VOC/VOT

Hoekplaat		41200		1,76	p/stuk	HA
-----------	--	-------	--	------	--------	----

Volbad thermisch verzinkte kabelladder VOT150

NIEDAX Typennummer	Afmetingen mm H x B	Artikel Nummer		 stuk/m	 VPE	Korting groep
-----------------------	---------------------------	-------------------	--	---	--	------------------

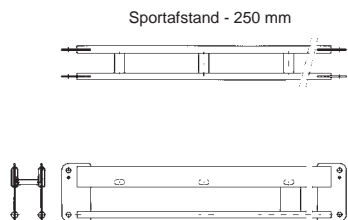

V **Kabelladder VOT150** excl. koppeling **lengte 6 meter**
gesloten, plat-ovale sporten (vulhoogte 40 mm)

Kabelladder 100	150 x 100	40101		4,72	6 m	HA
Kabelladder 200	150 x 200	40102		5,04	6 m	HA
Kabelladder 300	150 x 300	40103		5,37	6 m	HA
Kabelladder 400	150 x 400	40104		5,70	6 m	HA
Kabelladder 500	150 x 500	40105		6,03	6 m	HA
Kabelladder 600	150 x 600	40106		6,36	6 m	HA
Kabelladder 800	150 x 800	40108		7,01	6 m	HA
Kabelladder 1000	150 x 1000	40110		7,67	6 m	HA

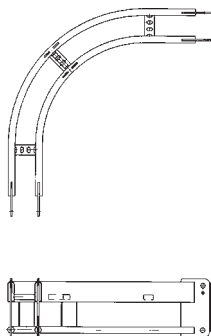

V **Binnenbocht 90° VOT150**
geperforeerde C - sport

Binnenbocht 100	150 x 100	41131		4,93	p/stuk	HA
Binnenbocht 200	150 x 200	41132		5,49	p/stuk	HA
Binnenbocht 300	150 x 300	41133		6,06	p/stuk	HA
Binnenbocht 400	150 x 400	41134		6,92	p/stuk	HA
Binnenbocht 500	150 x 500	41135		7,67	p/stuk	HA
Binnenbocht 600	150 x 600	41136		8,86	p/stuk	HA
Binnenbocht 800	150 x 800	41138		11,27	p/stuk	HA
Binnenbocht 1000	150 x 1000	41140		14,18	p/stuk	HA

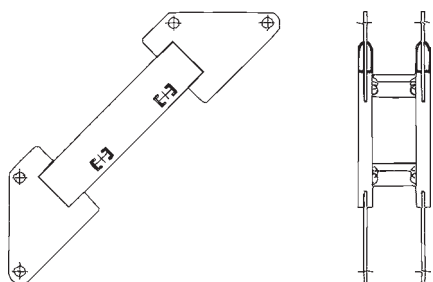

V **Stijgstuk 90° VOT150**
geperforeerde C - sport

Stijgstuk 100	150 x 100	41101		4,16	p/stuk	HA
Stijgstuk 200	150 x 200	41102		4,29	p/stuk	HA
Stijgstuk 300	150 x 300	41103		4,42	p/stuk	HA
Stijgstuk 400	150 x 400	41104		4,56	p/stuk	HA
Stijgstuk 500	150 x 500	41105		4,69	p/stuk	HA
Stijgstuk 600	150 x 600	41106		4,83	p/stuk	HA
Stijgstuk 800	150 x 800	41108		5,10	p/stuk	HA
Stijgstuk 1000	150 x 1000	41110		5,36	p/stuk	HA

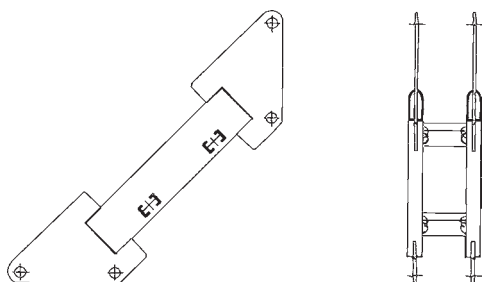

V **Vervalstuk 90° VOT150**
geperforeerde C - sport

Vervalstuk 100	150 x 100	41111		4,16	p/stuk	HA
Vervalstuk 200	150 x 200	41112		4,29	p/stuk	HA
Vervalstuk 300	150 x 300	41113		4,42	p/stuk	HA
Vervalstuk 400	150 x 400	41114		4,56	p/stuk	HA
Vervalstuk 500	150 x 500	41115		4,69	p/stuk	HA
Vervalstuk 600	150 x 600	41116		4,83	p/stuk	HA
Vervalstuk 800	150 x 800	41118		5,10	p/stuk	HA
Vervalstuk 1000	150 x 1000	41120		5,36	p/stuk	HA

NIEDAX Typennummer	Afmetingen mm H x B	Artikel Nummer		kg stuk	VPE	Korting groep
-----------------------	---------------------------	-------------------	--	------------	-----	------------------

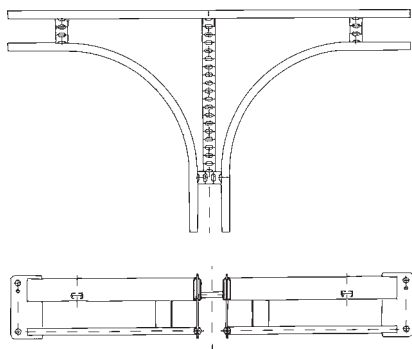

V T - Stuk VOT150
geperforeerde C - sport

T-Stuk 100	150 x 100	41151		8,27	p/stuk	HA
T-Stuk 200	150 x 200	41152		8,71	p/stuk	HA
T-Stuk 300	150 x 300	41153		9,53	p/stuk	HA
T-Stuk 400	150 x 400	41154		10,04	p/stuk	HA
T-Stuk 500	150 x 500	41155		10,48	p/stuk	HA
T-Stuk 600	150 x 600	41156		10,55	p/stuk	HA
T-Stuk 800	150 x 800	41158		12,80	p/stuk	HA
T-Stuk 1000	150 x 1000	41160		13,96	p/stuk	HA

Around
kabeladders

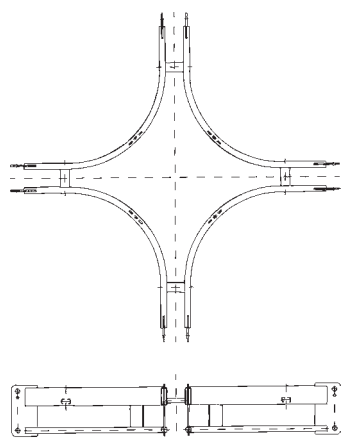

V Kruisstuk VOT150
geperforeerde C - sport

Kruisstuk 100	150 x 100	41161		10,34	p/stuk	HA
Kruisstuk 200	150 x 200	41162		10,74	p/stuk	HA
Kruisstuk 300	150 x 300	41163		11,14	p/stuk	HA
Kruisstuk 400	150 x 400	41164		12,89	p/stuk	HA
Kruisstuk 500	150 x 500	41165		13,43	p/stuk	HA
Kruisstuk 600	150 x 600	41166		13,97	p/stuk	HA
Kruisstuk 800	150 x 800	41168		16,92	p/stuk	HA
Kruisstuk 1000	150 x 1000	41170		20,42	p/stuk	HA

NIEDAX Typenummer	Afmetingen mm H x B	Artikel Nummer		kg stuk	VPE	Korting groep
----------------------	---------------------------	-------------------	--	------------	-----	------------------

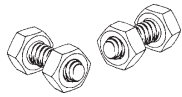

V Koppeling VOT150, recht (2 bouten en 2 moeren)

Koppeling		41212		0,42	10 St.	HA
-----------	--	-------	--	------	--------	----

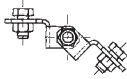

V Koppeling VOT150, horizontaal instelbaar (incl. bevestigingsmat.)

Koppeling		41213		0,80	10 St.	HA
-----------	--	-------	--	------	--------	----

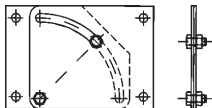
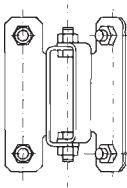

V Koppeling VOT150, verticaal instelbaar (incl. bevestigingsmat.)

Koppeling		41214		0,80	10 St.	HA
-----------	--	-------	--	------	--------	----

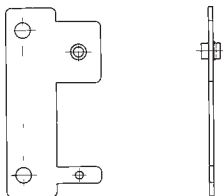

V Koppeling Inzetplaat VOT150 (incl. bevestigingsmat.)

Koppeling		41215		0,36	10 St.	HA
-----------	--	-------	--	------	--------	----



V Aftakhaak VOT150, inclusief bevestigingsmateriaal

Aftakhaak		41222		0,40	p/stuk	HA
-----------	--	-------	--	------	--------	----

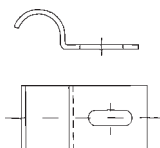

V Profielklem VOT150, inclusief bevestigingsmateriaal

Profielklem		41236		0,08	10 St.	HA
-------------	--	-------	--	------	--------	----

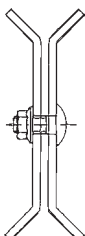

V Profielsteun VOT150, inclusief bevestigingsmateriaal

Profielsteun		41240		0,14	10 St.	HA
--------------	--	-------	--	------	--------	----



NIEDAX Typenummer	Afmetingen mm H x B	Artikel Nummer		 stuk/m	 VPE	Korting groep
----------------------	---------------------------	-------------------	--	---	--	------------------

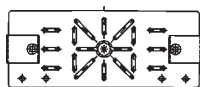

V Montageplaat VOC/VOT, horizontaal, vanaf ladderbreedte 200

Montageplaat		41250		0,82	5 St.	HA
--------------	--	--------------	--	------	-------	----

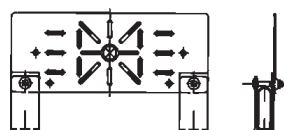

V Montageplaat VOC/VOT, verticaal

Montageplaat		41251		0,82	5 St.	HA
--------------	--	--------------	--	------	-------	----



V Scheidingsschot VOC/VOT, inclusief 3 houders per lengte

Scheidingsschot	30 x 25	41500		0,54	3 m	HA
-----------------	---------	--------------	--	------	-----	----

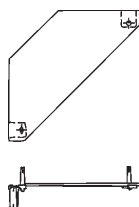

V Hoekplaat VOC/VOT

Hoekplaat		41200		1,76	10 St.	HA
-----------	--	--------------	--	------	--------	----

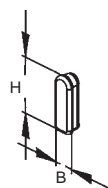

K Eindkap VOC/VOT, voor boomprofiel (P.E.), geel

Eindkap		41245		0,01	10/50 St.	HA
---------	--	--------------	--	------	-----------	----

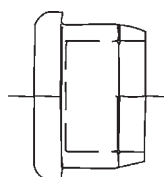

K Eindkap VOT, voor trekstang (P.E.), grijs

Eindkap		41246		0,01	10/50 St.	HA
---------	--	--------------	--	------	-----------	----

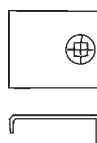

V Gootbevestigingsklem VOC/VOT (incl. bevestigingsmat.)

Bevestigingsklem		41252		0,03	5 St.	HA
------------------	--	--------------	--	------	-------	----

Deksels SOC/SOT sendzimir verzinkt

NIEDAX Typennummer	Afmetingen mm H x B	Artikel Nummer		kg stuk/m	VPE	Korting groep
-----------------------	---------------------------	-------------------	--	--------------	-----	------------------

S Deksel kabelladder SOC/SOT

lengte 3 meter

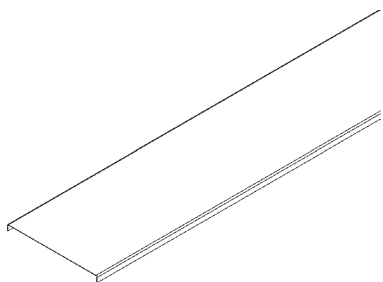

Deksel 100	100	41601		0,77	3 m	HA
Deksel 200	200	41602		1,37	3 m	HA
Deksel 300	300	41603		1,97	3 m	HA
Deksel 400	400	41604		3,40	3 m	HA
Deksel 500	500	41605		4,20	3 m	HA
Deksel 600	600	41606		6,20	3 m	HA
Deksel 800	800	41608		8,00	3 m	HA
Deksel 1000	1000	41610		9,90	3 m	HA

S Deksel binnenbocht 90° SOC/SOT



Deksel 100	100	41641		0,30	p/stuk	HA
Deksel 200	200	41642		0,50	p/stuk	HA
Deksel 300	300	41643		1,00	p/stuk	HA
Deksel 400	400	41644		1,50	p/stuk	HA
Deksel 500	500	41645		2,90	p/stuk	HA
Deksel 600	600	41646		4,00	p/stuk	HA
Deksel 800	800	41648		6,20	p/stuk	HA
Deksel 1000	1000	41650		8,50	p/stuk	HA

S Deksel buitenbocht 90° SOC/SOT



Deksel 100	100	41651		0,40	p/stuk	HA
Deksel 200	200	41652		0,60	p/stuk	HA
Deksel 300	300	41653		1,20	p/stuk	HA
Deksel 400	400	41654		1,80	p/stuk	HA
Deksel 500	500	41655		3,30	p/stuk	HA
Deksel 600	600	41656		4,50	p/stuk	HA
Deksel 800	800	41658		6,70	p/stuk	HA
Deksel 1000	1000	41660		10,00	p/stuk	HA

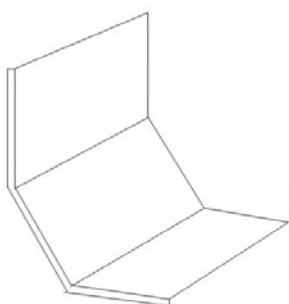

S Deksel stijgstuk 90° SOC60

Deksel 100	100	41611		0,31	p/stuk	HA
Deksel 200	200	41612		0,55	p/stuk	HA
Deksel 300	300	41613		0,80	p/stuk	HA
Deksel 400	400	41614		1,36	p/stuk	HA
Deksel 500	500	41615		1,68	p/stuk	HA
Deksel 600	600	41616		2,40	p/stuk	HA
Deksel 800	800	41618		3,20	p/stuk	HA
Deksel 1000	1000	41620		4,00	p/stuk	HA

NIEDAX Typenummer	Afmetingen mm H x B	Artikel Nummer		kg stuk	VPE	Korting groep
----------------------	---------------------------	-------------------	--	------------	-----	------------------

S Deksel vervalstuk SOC60

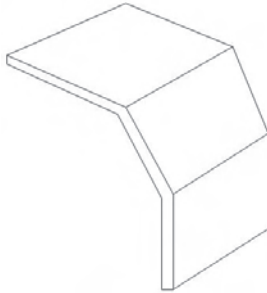

Deksel 100	100	41621		0,38	p/stuk	HA
Deksel 200	200	41622		0,68	p/stuk	HA
Deksel 300	300	41623		0,98	p/stuk	HA
Deksel 400	400	41624		1,70	p/stuk	HA
Deksel 500	500	41625		2,10	p/stuk	HA
Deksel 600	600	41626		3,10	p/stuk	HA
Deksel 800	800	41628		4,00	p/stuk	HA
Deksel 1000	1000	41630		5,00	p/stuk	HA

Around
kabeladders

S Deksel T-Stuk SOC/SOT

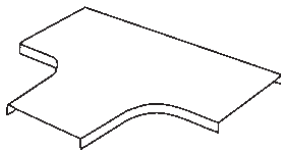

Deksel 100	100	41661		0,56	p/stuk	HA
Deksel 200	200	41662		1,20	p/stuk	HA
Deksel 300	300	41663		1,65	p/stuk	HA
Deksel 400	400	41664		2,70	p/stuk	HA
Deksel 500	500	41665		3,10	p/stuk	HA
Deksel 600	600	41666		4,50	p/stuk	HA
Deksel 800	800	41668		5,63	p/stuk	HA
Deksel 1000	1000	41670		9,10	p/stuk	HA

S Deksel kruisstuk SOC/SOT

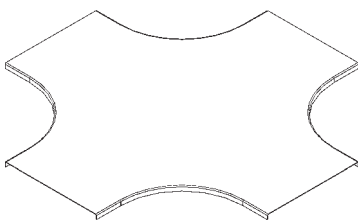

Deksel 100	100	41671		0,75	p/stuk	HA
Deksel 200	200	41672		1,60	p/stuk	HA
Deksel 300	300	41673		2,50	p/stuk	HA
Deksel 400	400	41674		3,50	p/stuk	HA
Deksel 500	500	41675		4,40	p/stuk	HA
Deksel 600	600	41676		6,00	p/stuk	HA
Deksel 800	800	41678		7,50	p/stuk	HA

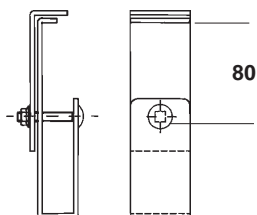

V Dekselondersteuning VOC/VOT (incl. bevestigingsmat.)

Dekselonderst.		41260		0,43	10 stuk	HA
----------------	--	-------	--	------	---------	----

Deksel VOC/VOT volbad thermisch verzinkt

NIEDAX Typennummer	Afmetingen mm H x B	Artikel Nummer		 stuk/m	 VPE	Korting groep
-----------------------	---------------------------	-------------------	--	---	--	------------------

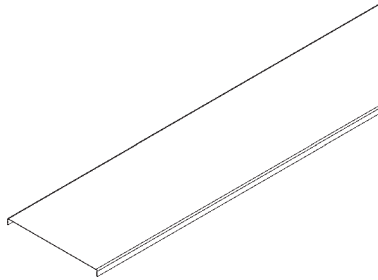

V Deksel kabelladder VOC/VOT

lengte 3 meter

Deksel 100	100	41301		0,77	3 m	HA
Deksel 200	200	41302		1,37	3 m	HA
Deksel 300	300	41303		1,97	3 m	HA
Deksel 400	400	41304		3,40	3 m	HA
Deksel 500	500	41305		4,20	3 m	HA
Deksel 600	600	41306		6,20	3 m	HA
Deksel 800	800	41308		8,00	3 m	HA
Deksel 1000	1000	41310		9,90	3 m	HA

V Deksel binnenbocht 90° VOC/VOT



Deksel 100	100	41341		0,30	p/stuk	HA
Deksel 200	200	41342		0,50	p/stuk	HA
Deksel 300	300	41343		1,00	p/stuk	HA
Deksel 400	400	41344		1,50	p/stuk	HA
Deksel 500	500	41345		2,90	p/stuk	HA
Deksel 600	600	41346		4,00	p/stuk	HA
Deksel 800	800	41348		6,20	p/stuk	HA
Deksel 1000	1000	41350		8,50	p/stuk	HA

V Deksel buitenbocht 90° VOC/VOT



Deksel 100	100	41351		0,40	p/stuk	HA
Deksel 200	200	41352		0,60	p/stuk	HA
Deksel 300	300	41353		1,20	p/stuk	HA
Deksel 400	400	41354		1,80	p/stuk	HA
Deksel 500	500	41355		3,30	p/stuk	HA
Deksel 600	600	41356		4,50	p/stuk	HA
Deksel 800	800	41358		6,70	p/stuk	HA
Deksel 1000	1000	41360		10,00	p/stuk	HA

V Deksel stijgstuk 90° VOC60

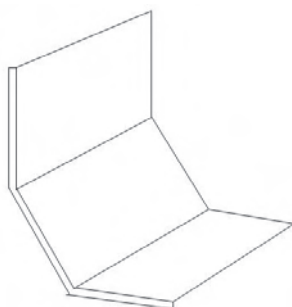

Deksel 100	100	41311		0,31	p/stuk	HA
Deksel 200	200	41312		0,55	p/stuk	HA
Deksel 300	300	41313		0,80	p/stuk	HA
Deksel 400	400	41314		1,36	p/stuk	HA
Deksel 500	500	41315		1,68	p/stuk	HA
Deksel 600	600	41316		2,40	p/stuk	HA
Deksel 800	800	41318		3,20	p/stuk	HA
Deksel 1000	1000	41320		4,00	p/stuk	HA



NIEDAX Typenummer	Afmetingen mm H x B	Artikel Nummer		 stuk	 VPE	Korting groep
----------------------	---------------------------	-------------------	--	---	--	------------------

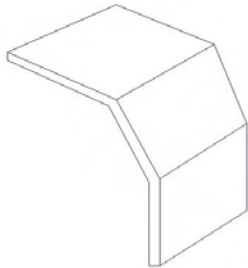

V Deksel vervalstuk VOC 60

Deksel 100	100	41321		0,38	p/stuk	HA
Deksel 200	200	41322		0,68	p/stuk	HA
Deksel 300	300	41323		0,98	p/stuk	HA
Deksel 400	400	41324		1,70	p/stuk	HA
Deksel 500	500	41325		2,10	p/stuk	HA
Deksel 600	600	41326		3,10	p/stuk	HA
Deksel 800	800	41328		4,00	p/stuk	HA
Deksel 1000	1000	41330		5,00	p/stuk	HA

Around
kabeladders

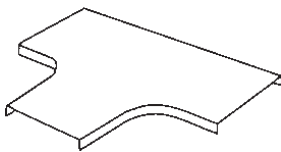

V Deksel T-Stuk VOC/VOT

Deksel 100	100	41361		0,56	p/stuk	HA
Deksel 200	200	41362		1,20	p/stuk	HA
Deksel 300	300	41363		1,65	p/stuk	HA
Deksel 400	400	41364		2,70	p/stuk	HA
Deksel 500	500	41365		3,10	p/stuk	HA
Deksel 600	600	41366		4,50	p/stuk	HA
Deksel 800	800	41368		5,63	p/stuk	HA
Deksel 1000	1000	41370		9,10	p/stuk	HA

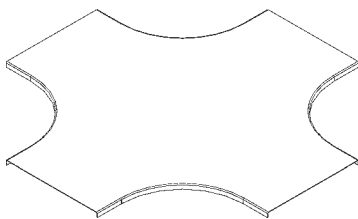

V Deksel kruisstuk VOC/VOT

Deksel 100	100	41371		0,75	p/stuk	HA
Deksel 200	200	41372		1,60	p/stuk	HA
Deksel 300	300	41373		2,50	p/stuk	HA
Deksel 400	400	41374		3,50	p/stuk	HA
Deksel 500	500	41375		4,40	p/stuk	HA
Deksel 600	600	41376		6,00	p/stuk	HA
Deksel 800	800	41378		7,50	p/stuk	HA
Deksel 1000	1000	41378		12,50	p/stuk	HA

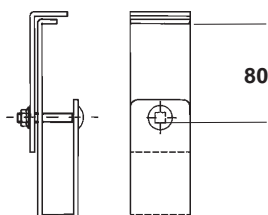

V Dekselondersteuning VOC/VOT (incl. bevestigingsmat.)

Dekselonderst.		41260		0,43	10 stuk	HA
----------------	--	--------------	--	------	---------	----

NIEDAX Typennummer	Afmetingen mm H x B	Artikel Nummer		kg stuk	VPE	Korting groep
------------------------------	---------------------------	---------------------------	--	------------	-----	------------------



Zinkcompound, blik 0,5 liter

Zinkcompound		46003			p/stu	netto
--------------	--	--------------	--	--	-------	-------



Zinkcompound, spuitbus 0,5 liter

Zinkcompound	Alu Chrome	46013			p/stuk	netto
--------------	------------	--------------	--	--	--------	-------



OPMERKINGEN

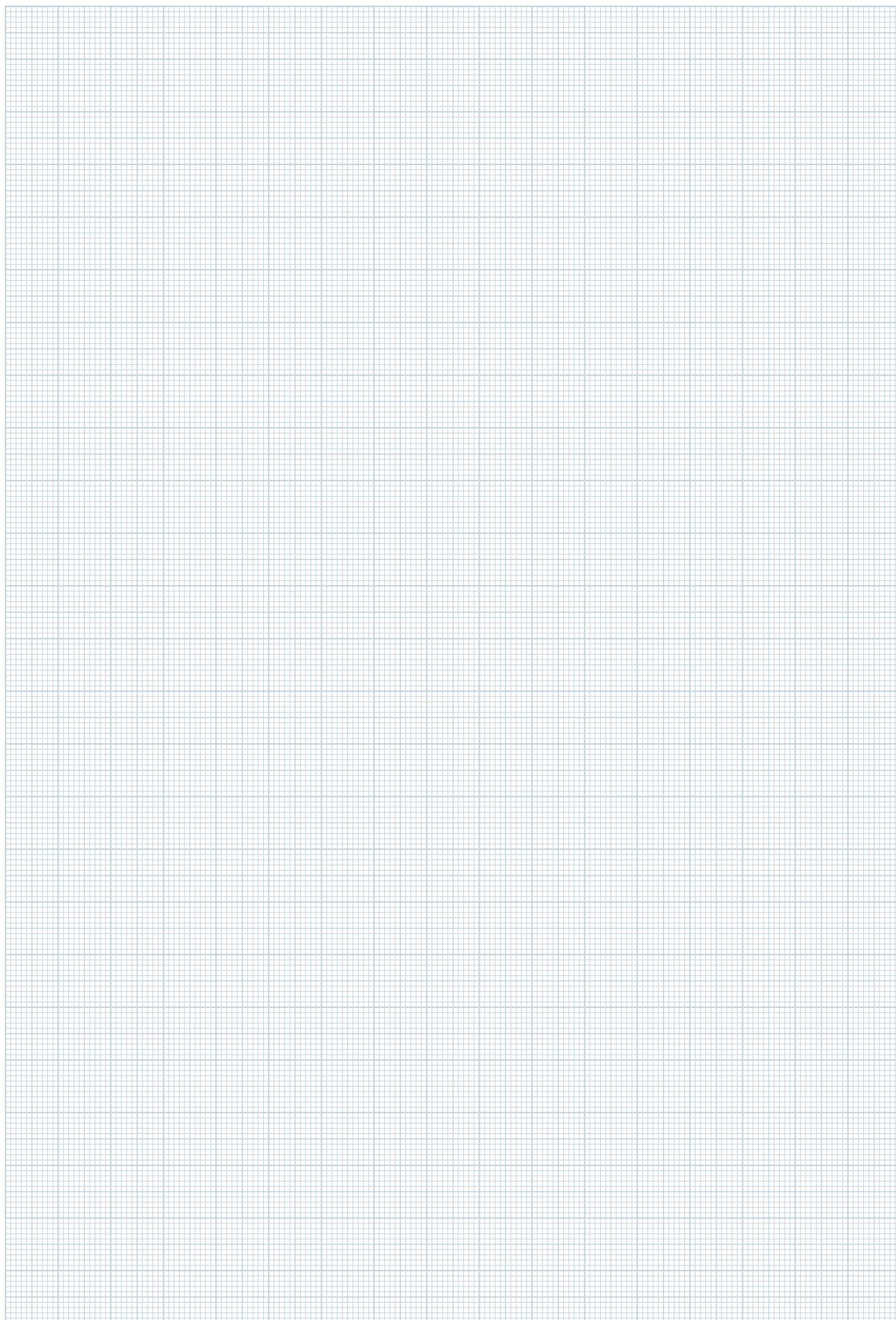

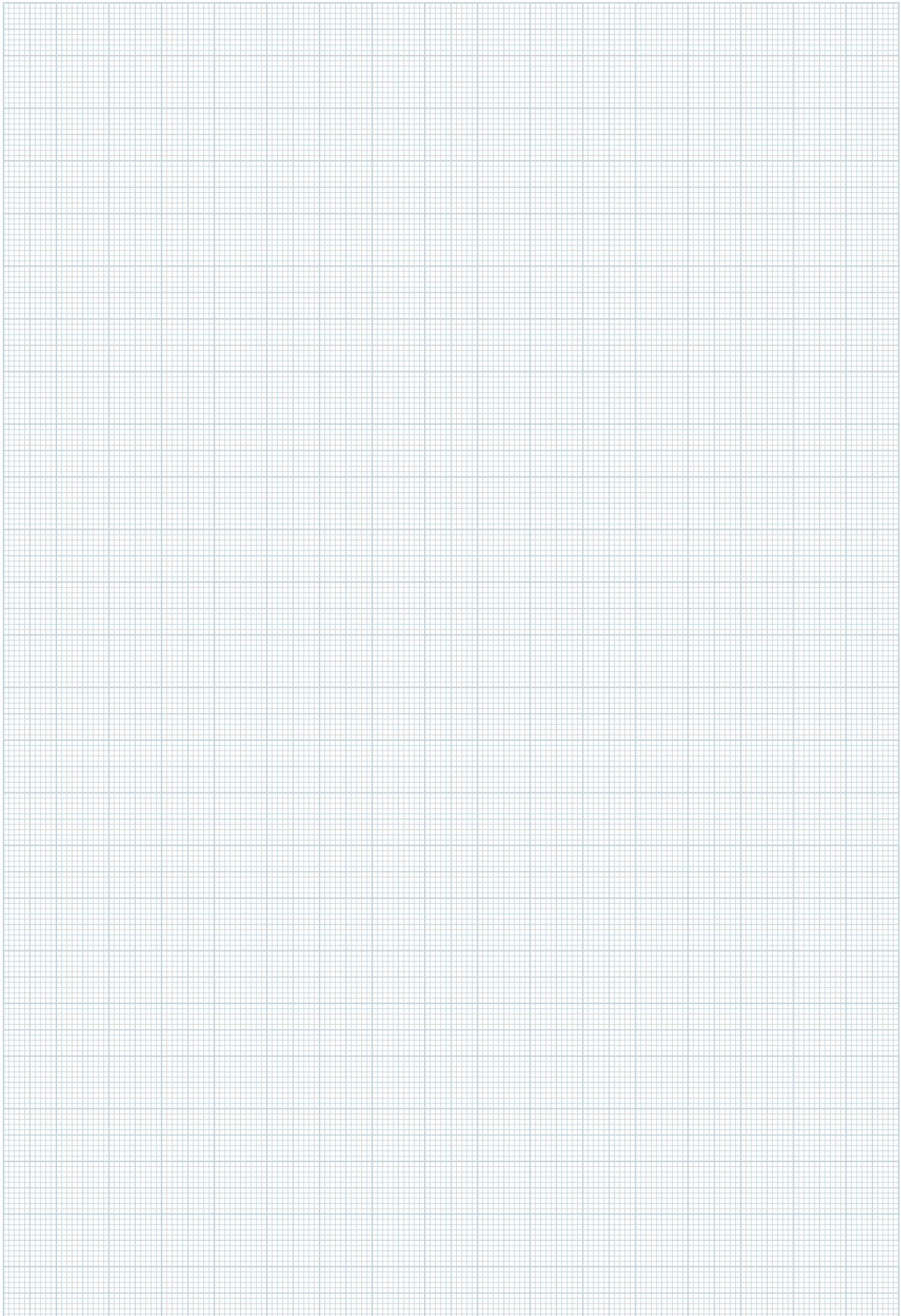

LEVERINGSVOORWAARDEN

Algemene leverings- en betalingsvoorwaarden van de besloten vennootschap Niedax Kleinhuis te Wijchen gedeponeerd ter griffie van de Arrondissementsrechtbank te Arnhem op 7 september 1987 onder nummer 2518/1987

Toepasselijkheid

De onderstaande leveringsvoorwaarden zijn van toepassing op al onze transacties. Afwijkingen van deze voorwaarden binden ons alleen indien deze vooraf door ons schriftelijk zijn bevestigd. Behoudens schriftelijke en uitdrukkelijke overeenkomst in andere zin binden inkoopvoorwaarden van afnemers ons niet.

Offerte

Alle offertes zijn vrijblijvend. Afbeeldingen, tekeningen, gewichten, afmetingen e.d. gelden slechts bij benadering, tenzij onzerzijds schriftelijk en uitdrukkelijk een garantie wordt verstrekt.

Prijzen

Onze prijzen zijn exclusief omzetbelasting, en uitgedrukt in Euro's. Wij behouden ons steeds het recht voor onze prijslijsten te wijzigen.

Kwaliteit en garantie

Wegens de levering van de goederen staan wij tegenover onze afnemers in voor de kwaliteitsnormen, welke vermeld worden in onze documentatie. Wij behouden ons het recht voor deze gegevens zonder voorafgaande mededeling te wijzigen. Overigens verstrekken wij geen verdere garantie, dan die welke onze eigen leverancier tegenover onszelf op zich neemt, tenzij van het tegendeel blijkt uit een door ons afgegeven schriftelijke garantieverklaring.

Levering

Goederen worden binnen Nederland franco geleverd. Op orders, met een lagere waarde dan € 170,- netto wordt een kostentoeslag berekend van € 14,-. Extra kosten van verzendingen, welke op verzoek van de afnemer per expresse of naar meerdere adressen worden verzonden, brengen wij in rekening. Verpakking is inclusief. Pallets en pallettranden worden in rekening gebracht en na franco-retourzending volledig gecrediteerd.

De door ons opgegeven levertijden gelden slechts bij benadering, tenzij een bepaalde leveringstermijn schriftelijk uitdrukkelijk is gegarandeerd. Overschrijding van bedoelde levertijden, door welke oorzaak ook, verplicht ons niet tot schadevergoeding, en geeft onze afnemer evenmin het recht tot ontbinding. Bij levering in gedeelten hebben wij het recht van betaling van eerdere deelleveringen te verlangen alvorens verdere leveringen te verrichten. Wij zijn niet gehouden overcomplete materialen retour te nemen. Retour te nemen goederen moeten in originele en onbeschadigde staat verkeren, en franco aan ons worden toegezonden. Accepteren wij de retourzending, dan wordt de gefactureerde waarde gecrediteerd onder aftrek van 10 % van het bruto bedrag. Speciaal behandelde of gefabriceerde materialen, danwel incurante materialen, kunnen nooit worden teruggenomen.

Eigendomsvoorbehoud.

Wij behouden ons de eigendom voor van alle door ons geleverde goederen totdat de afnemer aan al zijn financiële verplichtingen jegens ons zal hebben voldaan, waaronder de betaling van de geleverde goederen met eventuele rente en kosten. Het is de afnemer niet toegestaan de goederen te verpanden, in eigendom tot zekerheid over te dragen, of aan andere ter zake deze goederen rechten te verlenen. Indien de afnemer niet aan zijn verplichtingen jegens ons voldoet, zijn wij steeds bevoegd door ons geleverde goederen als ons eigendom terug te nemen, ongeacht waar zij zich bevinden.

Annulering

Bij overmacht of andere omstandigheden van zodanige aard, dat naar redelijkheid nakoming niet van ons kan worden geleverd, daaronder mede begrepen het geval, dat wij door onze eigen leveranciers, ongeacht de reden daartoe, niet tot levering in staat worden gesteld, zal de leveringsplicht worden opgeschort, en de levertijd worden verlengd met een tijdsduur gelijk aan die van het voortduren van die omstandigheden. Mocht de verlenging langer duren dan drie maanden dan zijn wij bevoegd de transactie voor het nog niet uitgevoerde deel geheel of gedeeltelijk te annuleren zonder tot enige vergoeding gehouden te zijn. In geval van gedeeltelijke annulering zal een corresponderend deel van de prijs door de afnemer verschuldigd zijn.

Betalingen

Betalingen dienen te geschieden binnen 30 dagen na factuurdatum, netto. Wij behouden ons het recht voor voorafgaande betaling of levering onder rembours te verlangen. Bij niet tijdige algehele betaling van de factuurbedragen binnen de overeengekomen betalingstermijn zullen wij steeds bevoegd zijn zonder nadere sommatie of ingebrekestelling de overeenkomst ontbonden te verklaren zonder dat rechtelijke tussenkomst zal zijn vereist, en ongeacht ons recht schadevergoeding te vorderen. Na het verstrijken van de betalingstermijn zijn wij gerechtigd 1 % verdragingsrente per maand in rekening te brengen. Alle kosten welke wij tot behoud van onze rechten dienstig mochten oordelen, zowel gerechtelijk als buitengerechtelijk, komen voor rekening van de afnemer, waarbij de buitengerechtelijke incassokosten worden gefixeerd op 10 % van het restant verschuldigd met een minimum van € 45,-. Wij behouden ons het recht voor met het oog op reeds geleverde of alsnog te leveren goederen zekerheid te verlangen voor de tijdige betaling van de koopsom in de vorm van vooruitbetaling, bankgarantie, borgtocht of eigendomsoverdracht tot zekerheid.

Reclames

Reclames worden alleen geaccepteerd, als zij binnen acht dagen na aflevering van de goederen schriftelijk kenbaar worden gemaakt. Het indienen van reclames ontheft niet van de verplichting tot betaling van de overeengekomen koopsom.

Geschillen

Alle geschillen zullen, naar onze keuze, worden berecht door de Arrondissementsrechtbank te Arnhem, dan wel de bevoegde rechter in de woonplaats van de afnemer.

